

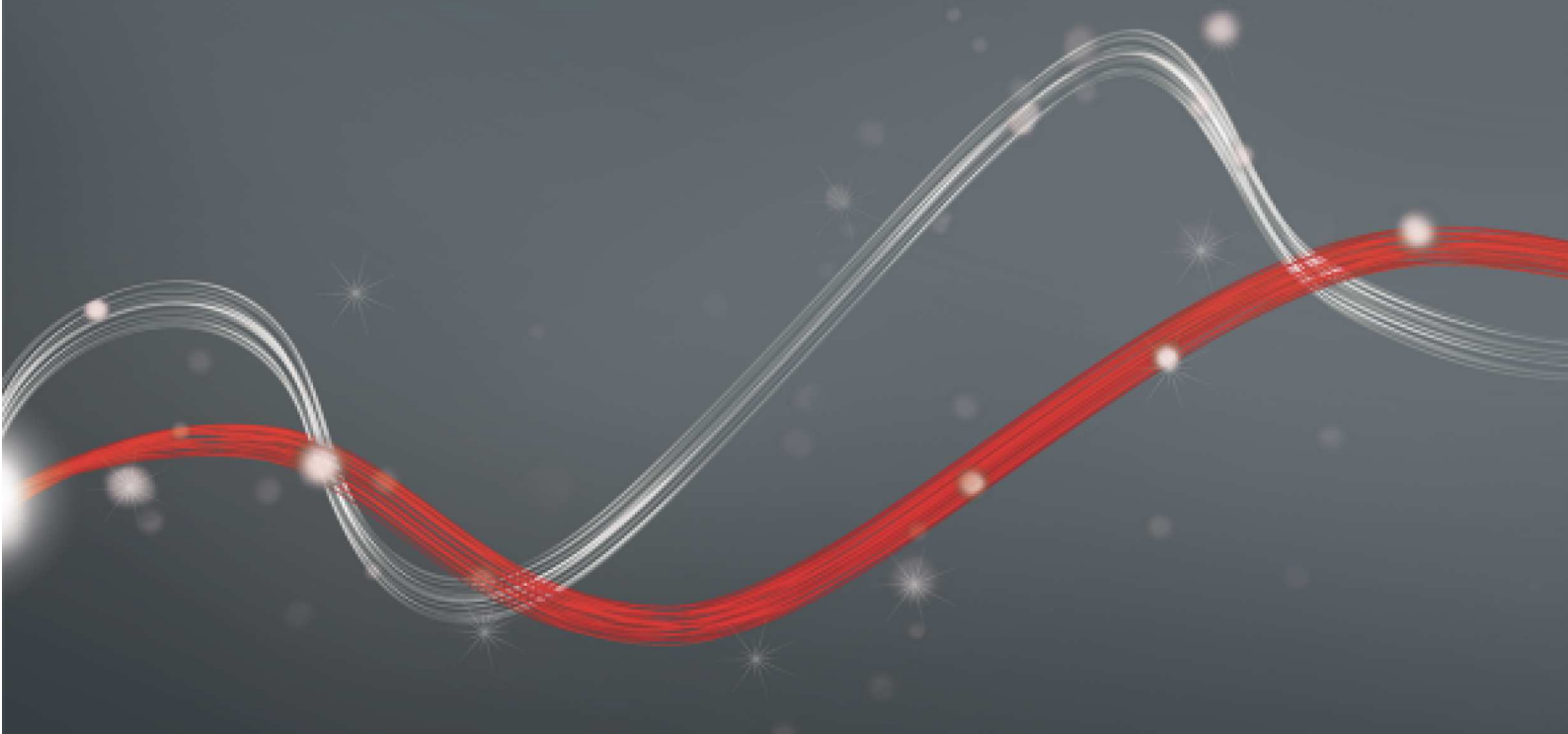

Be ahead



ICARO SMART AC A





ICARO SMART AC A



Sliding gate automation systems

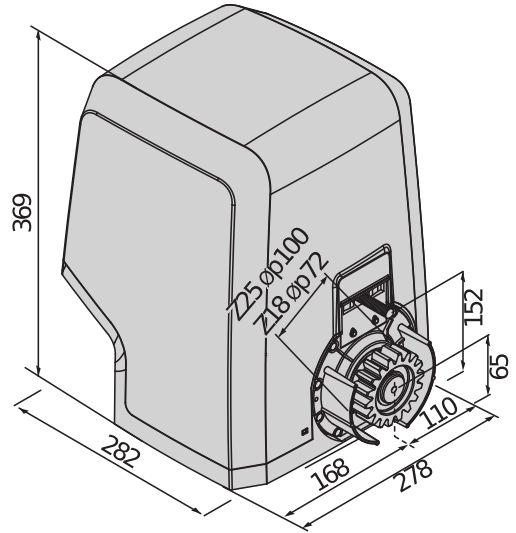

230V operators for sliding gates for very intensive use, extremely robust and high-performance thanks to oil bath transmission. Torque control thanks to D-Track technology and encoder for the highest possible precision of movement. Control unit for communication with U-Link protocol and with tamper-proof function. Operator with electromechanical limit switch. The control unit ensures complete safety thanks to the exclusive torque control system that makes these operators comply fully with the current European standards.

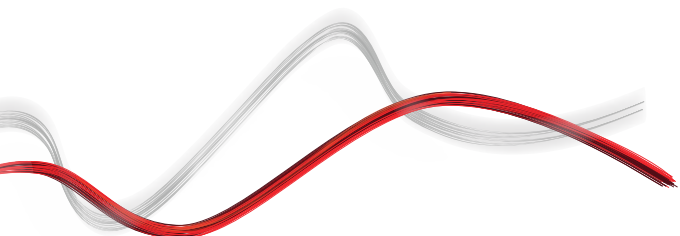



Sliding gate automation systems



ICARO SMART AC A

Code	Ci	Name	Description	
P925236 00002	2600853	ICARO SMART AC A2000	230 V operator for sliding gates up to 2000 kg with relative encoder. Gate panel speed 9 m/min . Electromechanical limit switch. Equipped with mechanical safety clutch, torque management via D-Track technology and oil bath gearbox. Control unit with display, preconfigured for communication with U-Link protocol.	
P925236 00003	2611614	ICARO SMART AC A2000 SQ	Operator 230 V for sliding gates up to 2000 kg in weight. Leaf speed 9 m/min. Limit switch Electromechanical.	
P925237 00002	2611618	ICARO SMART AC A2000 V	230 V operator for sliding gates up to 1000 kg with relative encoder. Gate panel speed 12 m/min . Electromechanical limit switch. Equipped with mechanical safety clutch, torque management via D-Track technology and oil bath gearbox. Electromechanical limit switch. Control unit with display, preconfigured for communication with U-Link protocol.	
P925237 00003	2611619	ICARO SMART AC A2000 V SQ	Operator 230 V for sliding gates up to 1000 kg in weight. Leaf speed 12 m/min. Limit switch Electromechanical.	
P925236 00001	2611613	ICARO SMART AC A2000 120	120 V operator for sliding gates up to 2000 kg with relative encoder. 9 m/min gate panel speed. Equipped with mechanical safety clutch, torque management via D-Track technology and oil bath gearbox. Limit switch Electromechanical. Control unit with display, preconfigured for communication with U-Link protocol.	
P925237 00001	2611617	ICARO SMART AC A2000 V 120	120 V operator for sliding gates up to 1000 kg with relative encoder. Gate panel speed 12 m/min . Electromechanical limit switch. Equipped with mechanical safety clutch, torque management via D-Track technology and oil bath gearbox. Control unit preconfigured for communication with U-Link protocol and with tamper-proof function. Operator with encoder and torque control using D-Track technology.	

LEO B CBB L02: Built-in control panel for 1 x 230V operator for sliding gates

LEO B CBB L02 - **Cp** I700073 10001 - **Ci** 2600768 - Built-in - (Spare part code, available for order through the Technical Support network)



- Built-in control panel for 1 x 230V operator for sliding gates
- Application: built-in control unit for one 230V operator for sliding gates
- Card power supply: 230 V single-phase
- Operator power supply: 230V 750W
- Main features: removable terminal blocks with new standard colour-coding, simplified scenario-based programming with display, incorporated dual channel receiver, D-Track anti-crushing system, slowdown during opening and closing
- Main functions: automatic re-closing, fast closing, pedestrian opening

	ICARO SMART AC A2000	ICARO SMART AC A2000 SQ	ICARO SMART AC A2000 V
Control unit	LEO B CBB L02	-	LEO B CBB L02
Board power supply	230 V	- V	230 V
Motor voltage	230 V	230 V	230 V
Power consumption	750 W	750 W	750 W
Max. door/gate weight	2000 kg	2000 kg	1000 kg
Gate panel speed	9 m/min	9 m/min	12 m/min
Type of limit switch	Electromechanical	Electromechanical	Electromechanical
Pinion module	4	4	4
Slowdown	Yes	Yes	Yes
Locking	Mechanical	Mechanical	Mechanical
Release	Lever-operated with personal key	Lever-operated with personal key	Lever-operated with personal key
Impact reaction	Mechanical clutch + encoder	Mechanical clutch + encoder	Mechanical clutch + encoder
Frequency of use	very intensive	very intensive	very intensive
Protection rating	IP24	IP24	IP24



ICARO SMART AC A





Sliding gate automation systems



	ICARO SMART AC A2000	ICARO SMART AC A2000 SQ	ICARO SMART AC A2000 V
Environmental conditions	-20 ÷ 55 °C	-20 ÷ 60 °C	-20 ÷ 55 °C
	ICARO SMART AC A2000 V SQ	ICARO SMART AC A2000 120	ICARO SMART AC A2000 V 120
Control unit	-	LEO B CBB L02	LEO B CBB L02
Board power supply	- V	230 V	230 V
Motor voltage	230 V	120 V	120 V
Power consumption	750 W	750 W	750 W
Max. door/gate weight	1000 kg	2000 kg	1000 kg
Gate panel speed	12 m/min	9 m/min	12 m/min
Type of limit switch	Electromechanical	Electromechanical	Electromechanical
Pinion module	4	4	4
Slowdown	Yes	Yes	Yes
Locking	Mechanical	Mechanical	Mechanical
Release	Lever-operated with personal key	Lever-operated with personal key	Lever-operated with personal key
Impact reaction	Mechanical clutch + encoder	Mechanical clutch + encoder	Mechanical clutch + encoder
Frequency of use	very intensive	very intensive	very intensive
Protection rating	IP24	IP24	IP24
Environmental conditions	-20 ÷ 55 °C	-20 ÷ 55 °C	-20 ÷ 55 °C

RECOMMENDED ACCESSORIES

	Cp D221073 - CI 2600594 CP plastic rack, 4-module, cross-section 22 x 22 mm, length 1 m, screw-fitted into slots attachment Max. load capacity 600 kg.		Cp N999320 - CI 2611083 CVZ-S steel rack, 4-module, cross-section 30 x 8 mm, length 1 m, screw-fitted on supports attachment Max. load capacity 800 kg.
	Cp D571053 - CI 9011069 CVZ steel rack, 4-module, cross-section 30 x 12 mm, length 1 m, screw-fitted on supports attachment Max. load capacity 1000 kg.		Cp D571054 - CI 2608387 CFZ galvanized steel rack, 4-module, cross-section 22 x 22 mm, length 2 m, welding attachment Max. load capacity 2000 kg.
	Cp D114093 00002 - CI 2607538 RADIUS LED AC A R1 Flashing light with incorporated antenna for motors with 230 V power supply.		Cp D114094 00002 - CI 2607540 RADIUS LED AC A RO Flashing light without incorporated antenna for motors with 230 V power supply.
	Cp P111782 - CI 2601411 COMPACTA A20-180 Pair of photocells adjustable 180° horizontally. 20 metre range. 12-33 VAC/15-35 VDC power supply.		Cp N999156 - CI 2611078 SFI Base plate for ARES and ICARO (supplied with operator)
	Cp P125018 - CI 2600843 THEKE B PRA 01 Metal protection box for ARES and ICARO series sliding operators		Cp P111468 - CI 2600811 B EBA RS 485 LINK Expansion board for connection of central units with serial controls management

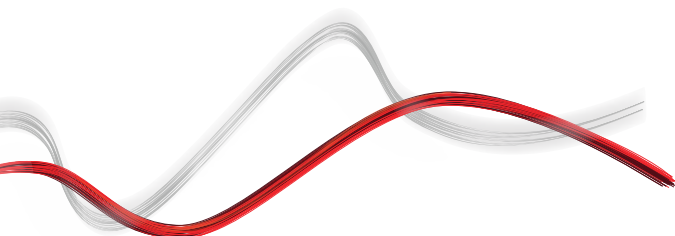



Sliding gate automation systems



Empowered by
U-LINK

EasyAXS

EASY CONNECT. EASY ACCESS.



The new connectivity solution which boosts the potential of BFT products and services to make access automations smarter and easier to use for both installers and end users.





Sliding gate automation systems



EASY TO CONNECT

WIFI MODULE



→ 10/15 metres

WIFI MODULE + ANTENNA



→ 20/25 metres

MOBILE MODULE + ANTENNA + SIM



→ ∞



**PLUG&PLAY
INSTALLATION**



**ALWAYS
CONNECTED**



**EVEN MORE
CONNECTIVITY**



**EASY TO SET UP
FOR INSTALLERS**



**EASY TO CONTROL
FOR CUSTOMERS**





Sliding gate automation systems



U-LINK 2.0

AN UPDATED VERSION OF
U-LINK TO GIVE YOU EVEN
MORE FUNCTIONALITY



Scalable

You can add as many devices as you want



Intuitive

Easy to install and to use



Functional

Settings can be controlled and firmware updated remotely using dedicated applications



Practical

Works with or without an internet connection



Flexible

It allows you to create groups of interconnected products

U-Link, the exclusive **BFT** technology platform has evolved to offer improved interaction with the latest generation of technological ecosystems. Its ability to interface with all home access automation access devices has been expanded, meaning it is now a very useful tool for installers. It is also a faster communication protocol with increased security for communicating information.

It allows you to save even more time, checking everything very easily and giving you even more peace of mind.



Sliding gate automation systems



Empowered by
U-LINK

U-SECURITY

A NEW AND EVEN MORE SECURE RADIO PROTOCOL



→ **Secure**

By transmitting data protected by a cryptographic key

U-Security is the new technology from **BFT** which incorporates encrypted rolling code thanks to the encryption key which masks the remote control code, meaning that it is impossible to clone a BFT remote control using another brand's model.

The functions of the **Er Ready** system are incorporated and a new procedure is also available for programming remote controls by scanning a QR CODE and using a special app. All products featuring this technology are **REPLAY**, so they can transmit the code to another BFT remote control using a combination of keys.



→ **Easy**

Pairing a remote control with a receiver can be done easily by scanning the QR code and using the dedicated app



→ **Universal**

The radio protocol is also compatible with the previous generation of receivers

